

Data Sheet

<p>DP-34044-4-000</p> <p><i>xtremeDB</i></p> <p><i>xDB16-PWMI</i></p> <p>Molded Plastic</p> <p>Output Module Digital and PWM(i)</p> <p>J1939</p> <p>8...32 V DC</p>	<p>Technical drawing showing dimensions for the DP-34044-4-000 module. Dimensions include: 8.07 [205] (total length), 3.80 [97] (height), 2.05 [52] (right side height), 10.43 [265] (main body length), 1.28 [33] (bottom height), 0.20 [5] (port offset), 0.30 [8] (port offset), 0.22 [6] (hole diameter), and 0.06 [2] (bottom edge offset). Connector types DT06-4S and DT16-18SA-K004 are indicated.</p>
---	--

Technical Data

Housing	Molded glass filled nylon
Dimensions (l x w x h)	3.80 x 10.43 x 1.34 in (97 x 265 x 34 mm)
Weight	1.5 lbs (0.68 kg)
Installation (mounting hardware not included)	Screw: 3 x #10 (3 x M5) Torque: 21 in-lbs (2.4 Nm) max.
Mating Connectors and Accessories Operating Voltage, Ground, and Configuration I/O-Ports	18 Pole Plug DT16-18SA or equivalent 4 Pole Plug 10 x DT06-4S or equivalent
DEUTSCH® size 16 Socket	0462-201-16141 (16 – 20 AWG) 1062-16-0122 (14 – 18 AWG) 114017
DEUTSCH® Seal Plug	
Cable Length	98.4 ft (30 m) max.
Operating Voltage	8...32 V DC protected against reverse polarity
Operating Current	13 Amps continuous per pin max. 52 Amps node current max.
Communication Interface and Baud Rate	2 non-isolated J1939 ports 250kb (default) & 500kb
Source Address	Base Address 224d (0xE0h) Offset 0...15 (J0: CNFGx-A/B)
Total Outputs	16 (12 paired 4 Amps, 2 x 4 Amps, 2 x 10 Amps)
Outputs Diagnostics	Short circuit and Overcurrent
Operating Temperature	-40...80 °C
Storage Temperature	-40...85 °C
Protection Class	IP67: Connector seal plugs required for unused pins. Sealing plugs required for unused ports IP68/IP69K: Using Murrelektronik MDC xtreme cables.

h	DCN 6022	08.28.23	AH				<p>Data Sheet</p> <p>xtremeDB PWM(i) Module J1939 xDB16-PWMI</p>	
g	DCN F750	09.09.21	FSa	Date	Name			
f	DCN F715	07.14.21	FSa	Originator	08.09.16	JNa		
e	DCN F363	08.11.20	FSa	Approved	09.21.16	KGu		
d	DCN F208	03.13.20	FSa					
c	Details corrected	10.26.16	JNa	<p>A Murrelektronik Company</p>			<p>Art. No.: DP-34044-4-000</p>	
Rev.	Description	Date	Name					Sheet
a	Initial release	09.21.16	JNa	DP-34044-4-000_db_e_g				1 of 5

The trademark DEUTSCH is owned by the TE Connectivity Ltd. family of companies.

Characteristics of the Output Ports

Outputs	Digital Output	Output voltage	8...32 V DC
		Switching current	4 Amps 10 Amps (Port1 A Pin-4) 10 Amps (Port3 A Pin-4)

	PWM & PWM(i) Output	PWM frequency	40-1100 Hz
		PWM(i) frequency	100-700 Hz
		Switching current	4 Amps
	Default configuration		Digital 4 Amps

Operating States (LEDs)	Color	Status
PWR	Blue	Module and Ports power are connected
COM & STAT	Green	Module and Communication status
FLT	Red	Fault Status
P1 – P4	Blue	Bus Power (Port Output Power)
OUT	Yellow	Left LED – Output A Right LED – Output B

h	DCN 6022	08.28.23	AH				Data Sheet xtremeDB PWM(i) Module J1939 xDB16-PWMI
g	DCN F750	09.09.21	FSa		Date	Name	
f	DCN F715	07.14.21	FSa	Originator	08.09.16	JNa	
e	DCN F363	08.11.20	FSa	Approved	09.21.16	KGU	
d	DCN F208	03.13.20	FSa	 A Murrelektronik Company			
c	Details corrected	10.26.16	JNa				Art. No.: DP-34044-4-000
Rev.	Description	Date	Name				
a	Initial release	09.21.16	JNa	DP-34044-4-000_db_e_g			The trademark DEUTSCH is owned by the TE Connectivity Ltd. family of companies.

Connector Interface

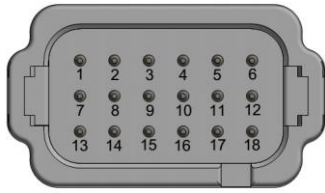

Connections J0:

1. BAUD1-A
2. CNFG1-A
3. CNFG2-A
4. CNFG3-A
5. CNFG4-A
6. BATTERY P4
7. BAUD1-B
8. CNFG1-B
9. CNFG2-B
10. CNFG3-B
11. CNFG4-B
12. GROUND B
13. BATTERY P1
14. BATTERY P2
15. BATTERY P3
16. GROUND B
17. GROUND B
18. GROUND B

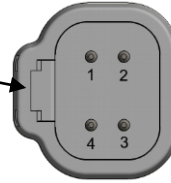
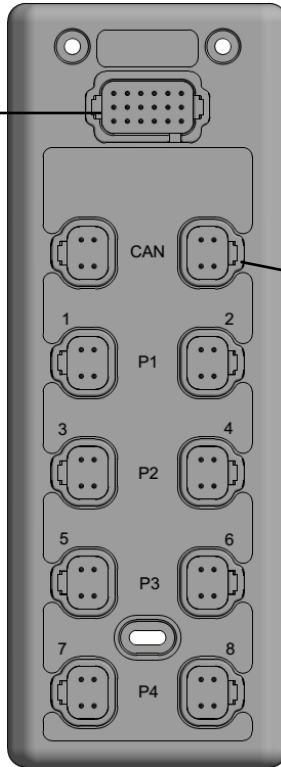

Connections:

CAN Port 1 & 2

- Pin 1 = POWER
- Pin 2 = CAN HIGH
- Pin 3 = GROUND A
- Pin 4 = CAN LOW

OUTPUT Ports 1 to 8

- Pin 1 = GROUND B
- Pin 2 = OUTPUT B
- Pin 3 = GROUND B
- Pin 4 = OUTPUT A



Proper installation and operation of the xtremeDB blocks requires the use of all ground connections. This includes Ground (A) for module power and Ground (B) for port power on the 18 pin configuration and power plug.

h	DCN 6022	08.28.23	AH				Data Sheet xtremeDB PWM(i) Module J1939 xDB16-PWMi	Art. No.: DP-34044-4-000	<i>Sheet</i> 3 of 5
g	DCN F750	09.09.21	FSa		Date	Name			
f	DCN F715	07.14.21	FSa	Originator	08.09.16	JNa			
e	DCN F363	08.11.20	FSa	Approved	09.21.16	KGu			
d	DCN F208	03.13.20	FSa	 A Murrelektronik Company					
c	Details corrected	10.26.16	JNa						
Rev.	Description	Date	Name						
a	Initial release	09.21.16	JNa	DP-34044-4-000_db_e_g			The trademark DEUTSCH is owned by the TE Connectivity Ltd. family of companies.		

DP-34044-4.XXX I/O Diagram

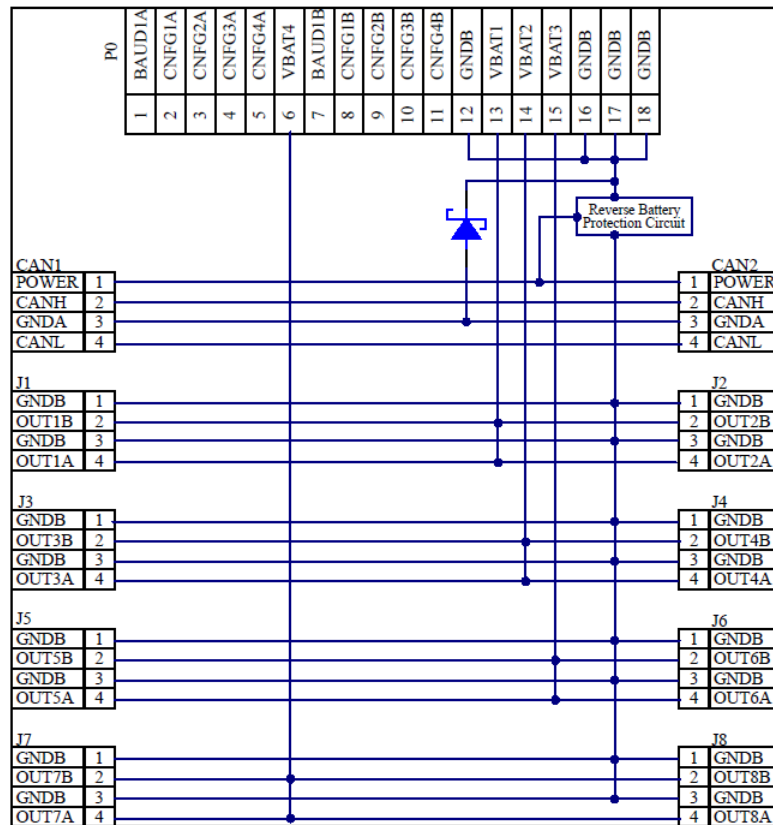

Derating Curve Max Total Current

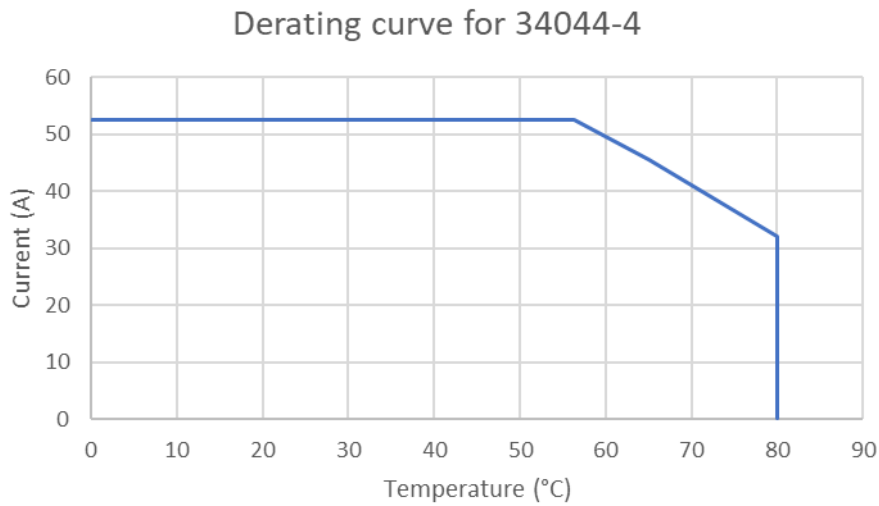

h	DCN 6022	08.28.23	AH				Data Sheet xtremeDB PWM(i) Module J1939 xDB16-PWMI
g	DCN F750	09.09.21	FSa		Date	Name	
f	DCN F715	07.14.21	FSa	Originator	08.09.16	JNa	
e	DCN F363	08.11.20	FSa	Approved	09.21.16	KGu	
d	DCN F208	03.13.20	FSa	 A Murrelektronik Company			
c	Details corrected	10.26.16	JNa				
Rev.	Description	Date	Name	Art. No.: DP-34044-4-000			<i>Sheet</i> 4 of 5
a	Initial release	09.21.16	JNa				

Test Standards and Regulation

<i>Climatic test</i>	Cold Temperature to IEC 60068-2-1:2007, test Ad Dry Heat to IEC 60068-2-2:2007, test Bb Temperature Durability to IEC 60068-2-14:2000-08, test Nb Temperature Shock to IEC 60068-2-14:2000-08, test Na Humidity Soak to IEC 60068-2-78:2001, test Cab Humidity Cycle to IEC 60068-2-30:2005, test Db
<i>Mechanical test</i>	Swept Sine Vibration to IEC 60068-2-6:2007, test Fc Random Vibration to IEC 60068-2-64:2008, test Fh Resonance Vibration to IEC 60068-2-6:2007, Section 8.1 Mechanical Shock to EN 60068-2-27:2008, test Ea Mechanical Bump to EN 60068-2-27:2008, test Ec IP protection to EN 60529:2000-09, test IP67, IP68, IP69K Chemical Loads to ISO 16750-5:2010 Part 5: AA, BA, BC, BD, BE, CC, DB, DD
<i>Electrical test</i>	Electrical Tests to ISO 16750-2:2012 EMC Immunity to ISO 13766-1:2018, ISO 13766-2:2018, ISO 13309:2010 EMC Emissions to ISO 13766-1:2018, ISO 13766-2:2018, ISO 13309:2010 Conducted Transients to ISO 13766-1:2018, ISO 13766-2:2018, ISO7637-2:2011, Annex A
<i>CE</i>	RoHS: Directive 2011/65/EU EMI/EMC: Directive 2014/30/EU

Article Numbers

DP-34044-4-000	J1939 Slave Module
DP-34044-4-200	CANOpen Slave module



h	DCN 6022	08.28.23	AH				Data Sheet xtremeDB PWM(i) Module J1939 xDB16-PWMi
g	DCN F750	09.09.21	FSa	Date	Name		
f	DCN F715	07.14.21	FSa	Originator	08.09.16	JNa	
e	DCN F363	08.11.20	FSa	Approved	09.21.16	KGu	
d	DCN F208	03.13.20	FSa	 A Murrelektronik Company			
c	Details corrected	10.26.16	JNa				Art. No.: DP-34044-4-000
Rev.	Description	Date	Name				
a	Initial release	09.21.16	JNa	DP-34044-4-000_db_e_g			The trademark DEUTSCH is owned by the TE Connectivity Ltd. family of companies.