

Data Sheet

DP-34045-5-000

xtremeDB
xDB-5-16IO
Passive Module
w/o LEDs
Common Bus
8-32 Vdc
United States
Patent:
US 10,069,226
Sep. 4, 2018

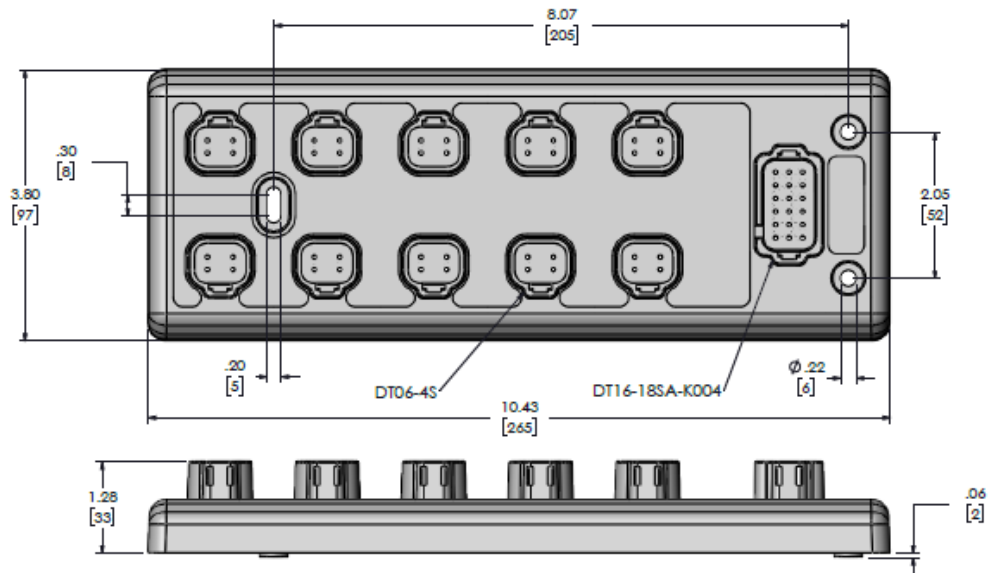

Technical Data

Housing	Molded glass filled nylon
Dimensions (l x w x h)	3.80 x 10.43 x 1.34 in (97 x 265 x 34 mm)
Weight	1.5 lbs (0.68 kg)
Installation (mounting hardware not included)	Screw: 3 x #10 (3 x M5) Torque: 21 in-lbs (2.4 Nm) max.
Mating Connectors and Accessories Operating Voltage, Ground, and Configuration I/O-Ports	18 Pole Plug DT16-18SA or equivalent 4 Pole Plug 10 x DT06-4S or equivalent
DEUTSCH size 16 Socket	0462-201-16141 (16 – 20 AWG) 1062-16-0122 (14 – 18 AWG) 114017
DEUTSCH Seal Plug	
Total I/O	16 (2 mirrored ports: ports 7 & 9 and ports 8 & 10)
Operating Voltage (COMMON)	8...32 V DC or Ground
Current (COMMON)	13 A per pin max.
Current (IO)	8 A per pin max.
Total Node Current	52 A max.
Operating Temperature	-40...80 °C
Storage Temperature	-40...85 °C
Protection Class	IP67: Connector seal plugs required for unused pins. Sealing plugs required for unused ports IP68/IP69K: Using MDC xtreme cables.





g	DCN 6022	08.28.23	AH		Date	Name	Data Sheet xtremeDB Passive Module xDB-5-16IO
f	DCN F645	05.05.21	FSa	Originator	11.30.17	JNa	
e	DCN F412	10.02.20	TMc	Approved	11.30.17	VJi	
d	DCN F256	05.18.20	FSa				
c	DCN F112	12.02.19	FSa	 A Murrelektronik Company			Art. No.: DP-34045-5-000
Rev.	Description	Date	Name				
b	initial release	11.30.17	JNa	DP-34045-5-000_db_e_f	The trademark DEUTSCH is owned by the TE Connectivity Ltd. family of companies.		Sheet 1 of 4

Test Standards and Regulation

<i>Climatic Tests</i>	Cold Temperature to IEC 60068-2-1:2007, test Ad Dry Heat to IEC 60068-2-2:2007, test Bb Temperature Durability to IEC 60068-2-14:2000-08, test Nb Temperature Shock to IEC 60068-2-14:2000-08, test Na Humidity Soak to IEC 60068-2-78:2001, test Cab Humidity Cycle to IEC 60068-2-30:2005, test Db
<i>Mechanical Tests</i>	Swept Sine Vibration to IEC 60068-2-6:2007, test Fc Random Vibration to IEC 60068-2-64:2008, test Fh Resonance Vibration to IEC 60068-2-6:2007, Section 8.1 Mechanical Shock to EN 60068-2-27:2008, test Ea Mechanical Bump to EN 60068-2-27:2008, test Ec IP protection to EN 60529:2000-09, test IP67, IP68, IP69K Chemical Loads to ISO 16750-5:2010 Part 5: AA, BA, BC, BD, BE, CC, DB, DD
<i>CE</i>	RoHS: Directive 2011/65/EU

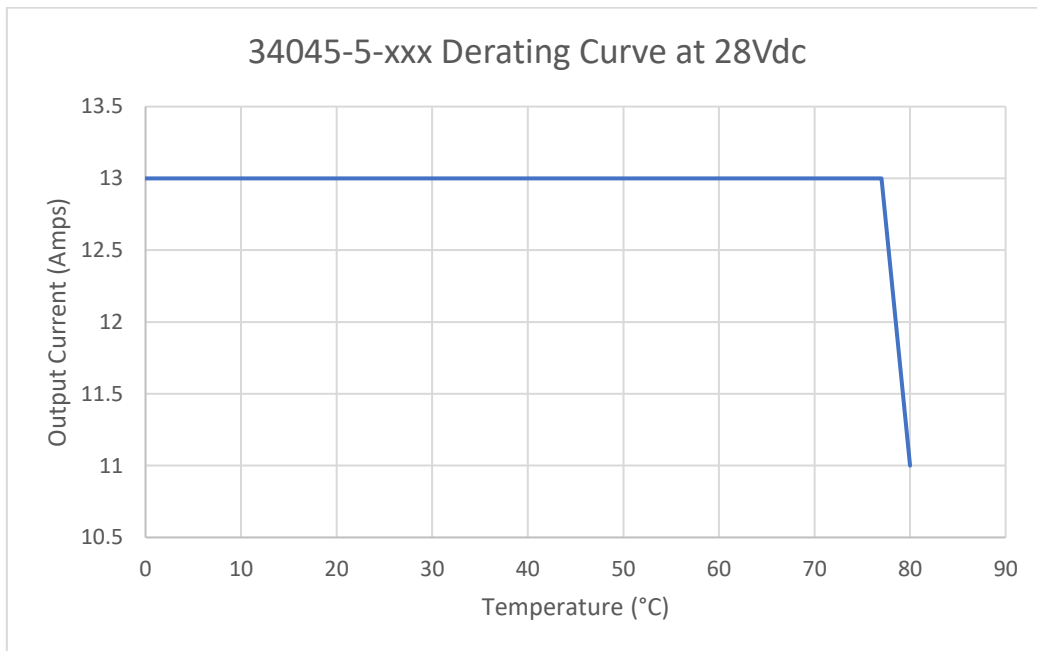
Derating Curve



g	DCN 6022	08.28.23	AH		Date	Name	Data Sheet xtremeDB Passive Module xDB-5-16IO
f	DCN F645	05.05.21	FSa	Originator	11.30.17	JNa	
e	DCN F412	10.02.20	TMc	Approved	11.30.17	VJi	
d	DCN F256	05.18.20	FSa	 A Murrelektronik Company			
c	DCN F112	12.02.19	FSa				
Rev.	Description	Date	Name				Art. No.: DP-34045-5-000
b	initial release	11.30.17	JNa	DP-34045-5-000_db_e_f	The trademark DEUTSCH is owned by the TE Connectivity Ltd. family of companies.		

Connector Interface

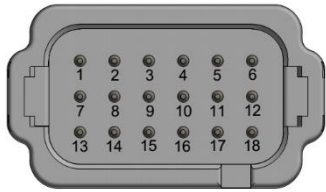

Connections:

1. Port 1, Pin 4: IO-1A
2. Port 1, Pin 2: IO-1B
3. Port 2, Pin 4: IO-2A
4. Port 2, Pin 2: IO-2B
5. Port 3, Pin 4: IO-3A
6. Port 3, Pin 2: IO-3B
7. Port 4, Pin 4: IO-4A
8. Port 4, Pin 2: IO-4B
9. Port 5, Pin 4: IO-5A
10. Port 5, Pin 2: IO-5B
11. Port 6, Pin 4: IO-6A
12. Port 6, Pin 2: IO-6B
13. Port 7 & 9, Pin 4: IO-7A
14. Port 7 & 9, Pin 2: IO-7B
15. Port 8 & 10, Pin 4: IO-8A
16. Port 8 & 10, Pin 2: IO-8B
17. COMMON
18. COMMON

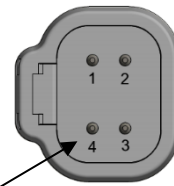
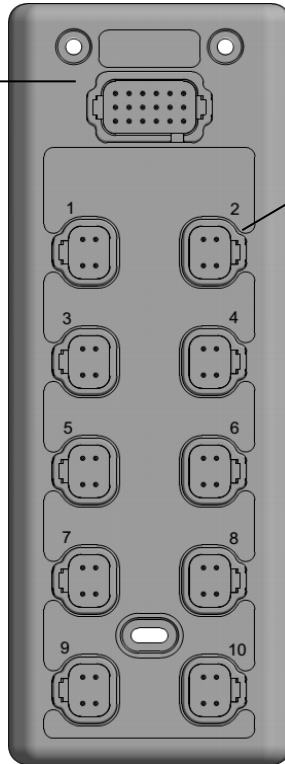

Connections:

Power Ports 1 to 10
 Pin 1 = COMMON
 Pin 3 = COMMON

Input/IO-Ports 1 to 10

Port 1, Pin 4: IO-1A
 Port 1, Pin 2: IO-1B

Port 2, Pin 4: IO-2A
 Port 2, Pin 2: IO-2B

Port 3, Pin 4: IO-3A
 Port 3, Pin 2: IO-3B

Port 4, Pin 4: IO-4A
 Port 4, Pin 2: IO-4B

Port 5, Pin 4: IO-5A
 Port 5, Pin 2: IO-5B

Port 6, Pin 4: IO-6A
 Port 6, Pin 2: IO-6B

Port 7 & 9, Pin 4: IO-7A
 Port 7 & 9, Pin 2: IO-7B

Port 8 & 10, Pin 4: IO-8A
 Port 8 & 10, Pin 2: IO-8B

g	DCN 6022	08.28.23	AH		Date	Name	Data Sheet xtremeDB Passive Module xDB-5-16IO	
f	DCN F645	05.05.21	FSa	Originator	11.30.17	JNa		
e	DCN F412	10.02.20	TMc	Approved	11.30.17	VJi		
d	DCN F256	05.18.20	FSa	 A Murrelektronik Company				
c	DCN F112	12.02.19	FSa				Art. No.: DP-34045-5-000	Sheet 3 of 4
Rev.	Description	Date	Name					
b	initial release	11.30.17	JNa	DP-34045-5-000_db_e_f			The trademark DEUTSCH is owned by the TE Connectivity Ltd. family of companies.	

Connector Wire Diagram

34045-5-000 I/O Diagram

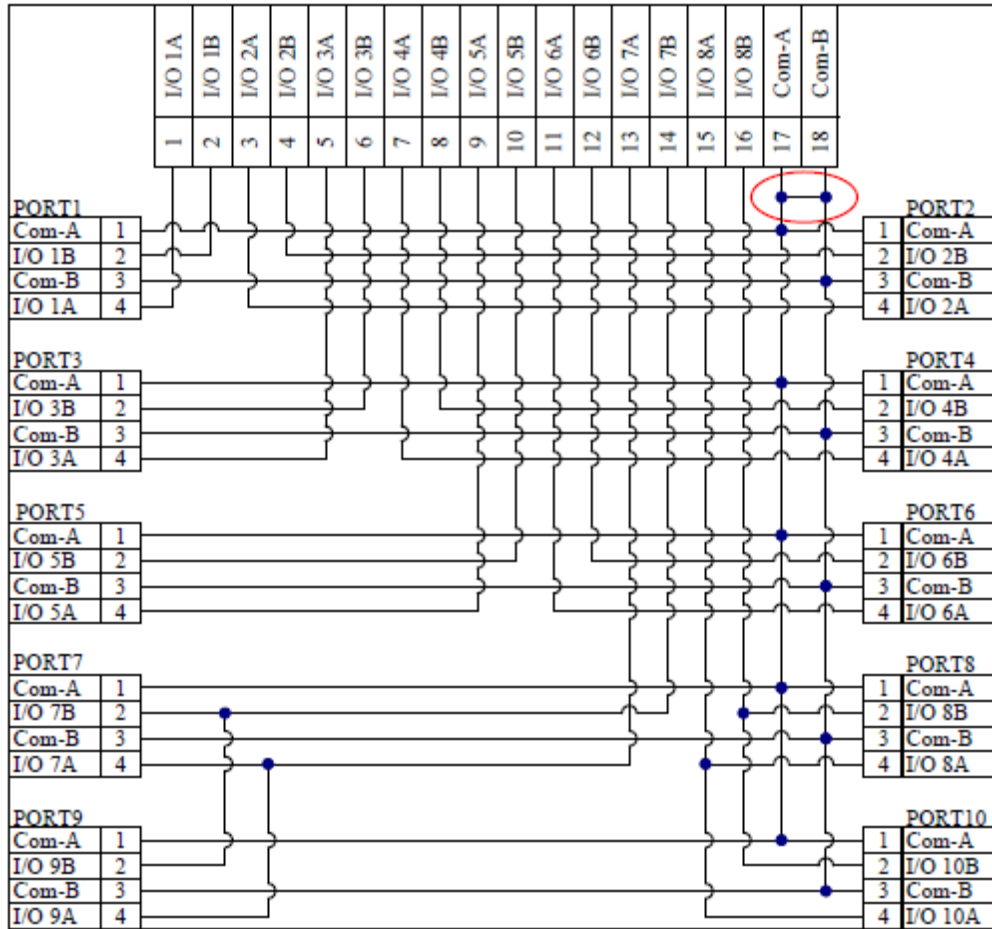

**PORT LED
CONFIGURATION**

NO LED_s

g	DCN 6022	08.28.23	AH		Date	Name	Data Sheet xtremeDB Passive Module xDB-5-16IO	
f	DCN F645	05.05.21	FSa	Originator	11.30.17	JNa		
e	DCN F412	10.02.20	TMc	Approved	11.30.17	VJi		
d	DCN F256	05.18.20	FSa	 A Murrelektronik Company				
c	DCN F112	12.02.19	FSa				Art. No.: DP-34045-5-000	
Rev.	Description	Date	Name					
b	initial release	11.30.17	JNa	DP-34045-5-000_db_e_f			The trademark DEUTSCH is owned by the TE Connectivity Ltd. family of companies.	